

SLIDING DOOR SYSTEMS: ASSEMBLY INSTRUCTIONS

STOPPER FOR TOP TRACK WITH AND WITHOUT END CAP

6th edition Bremen, February 2012

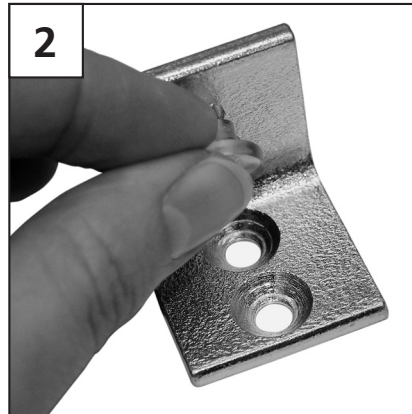
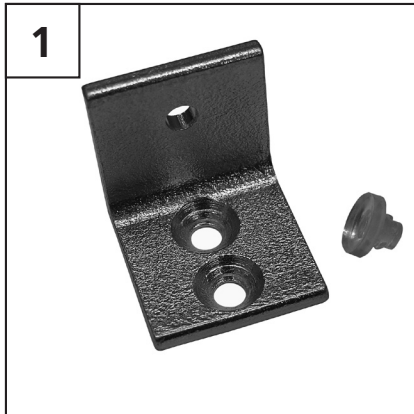

If you would like to attach the stopper to the top track without a cover, then take the included rubber impact buffer and put it in the designated place (see picture 2, in case it is not attached).

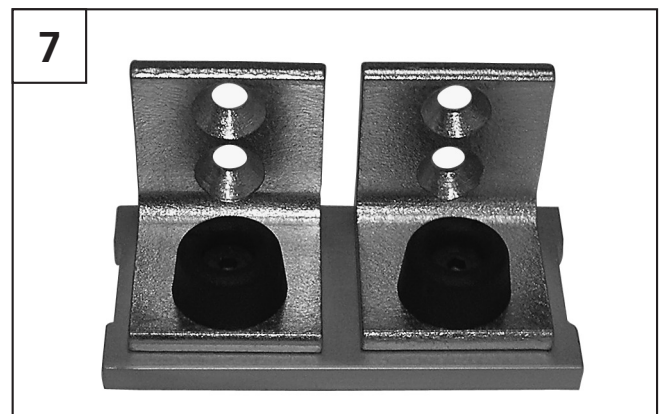
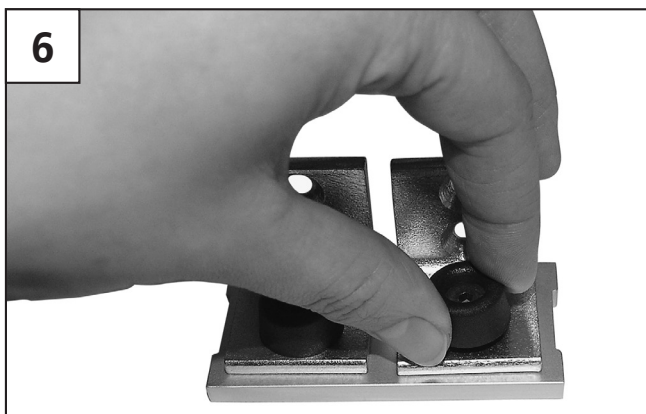
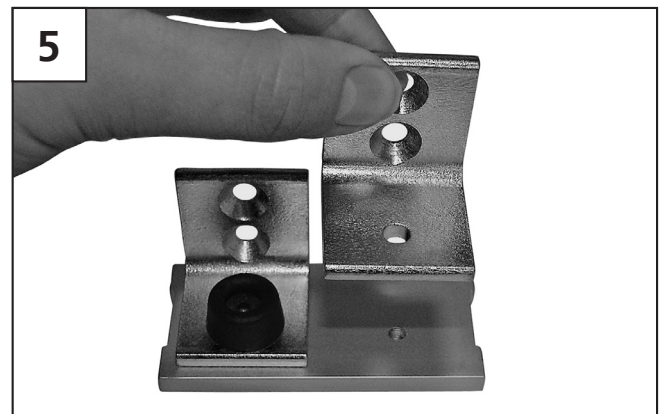
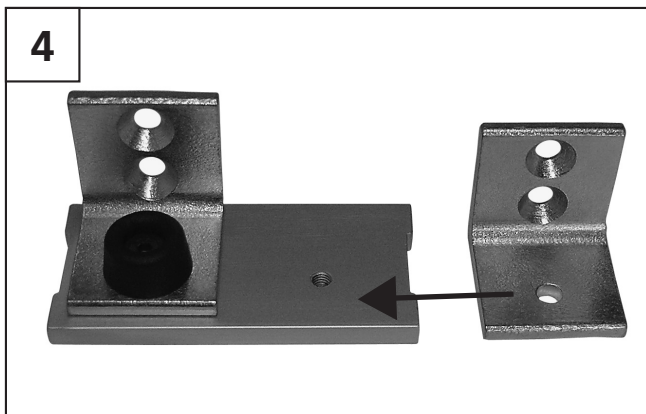

If you would like to insert a cover, then you must use a black rubber stopper (see picture). Put the angle on the cover in the designated position and attach it to the cover with the black rubber stopper.

SLIDING DOOR SYSTEM: ASSEMBLY INSTRUCTION

STOPPER FOR TOP TRACK WITH AND WITHOUT END CAP

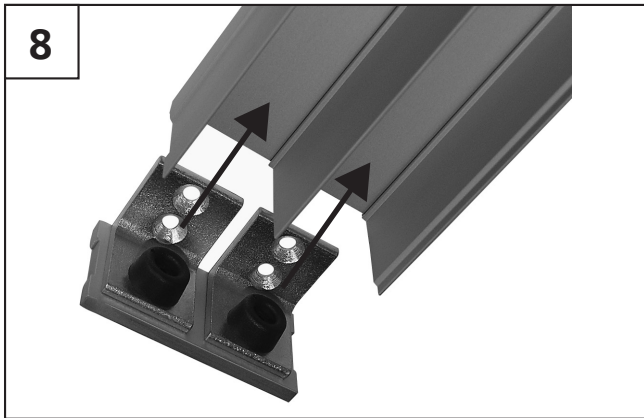

Push the top track stoppers into the top track and mount them professionally according to the substructure.

ACCESSORIES:

1_Stopper for top track for 34 mm systems (10.08.48x)_

2_Stopper for top track for 42 mm systems (10.08.49x)_

3_End cap for 34 mm systems (silver, 10.08.281 one-track, 10.08.282 two-track, 10.08.283 three-track)_

4_End cap 42 mm systems (silver, 10.08.291 one-track, 10.08.292 two-track, 10.08.293 three-track)_

	easy	medium	difficult
Install	<div style="width: 33%; background-color: #cccccc;"></div>	<div style="width: 33%; background-color: #cccccc;"></div>	<div style="width: 33%; background-color: #cccccc;"></div>
Assemble	<div style="width: 33%; background-color: #cccccc;"></div>	<div style="width: 33%; background-color: #cccccc;"></div>	<div style="width: 33%; background-color: #cccccc;"></div>

Subject to technical changes.